

**VIDÃO**  
**STAR1614**  
**Laser Light Projector**

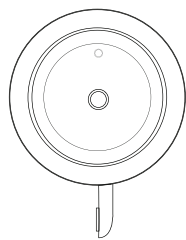

For Troubleshooting Assistance call 1-855-998-4326  
 or visit [www.sibrandssupport.com](http://www.sibrandssupport.com)

**In the Box**



Laser Light Projector

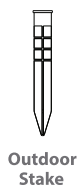

Outdoor Stake

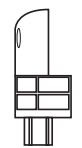

Stake Adaptor



Thumbscrew



Fastener

**Location of Controls**

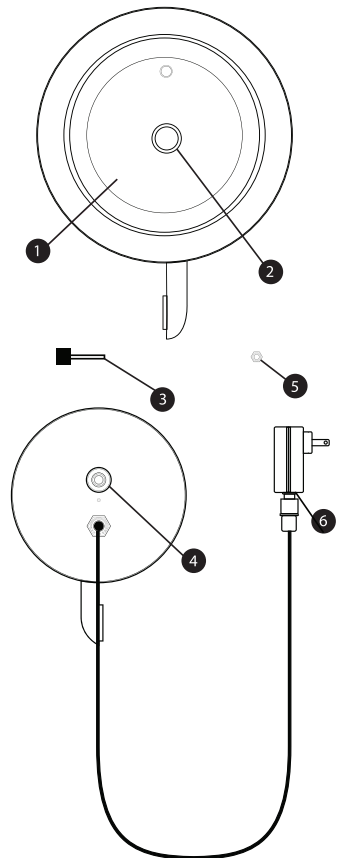

1. Front lens
2. Laser lights
3. Thumbscrew
4. [POWER] button
5. Fastener
6. AC Adaptor

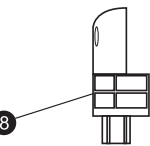
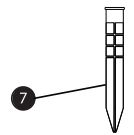

**Using the Outdoor Stake**

1. Gently push the outdoor stake into the ground (If you are having difficulty mounting the outdoor stake, a rubber mallet can be used to safely secure it in the ground).
2. Loosen the thumbscrew on the side of the Laser Light Projector to remove the projector from the mounting base.
3. Attach the outdoor stake adaptor. Slide the thumbscrew into position.
4. Secure the thumbscrew with the included fastener. Adjust the arm toward the outdoor stake and tighten the thumbscrew.
5. Connect Laser Light Projector to the outdoor stake.
6. Plug the Laser Light Projector into an outdoor electrical outlet.

Figure 2.

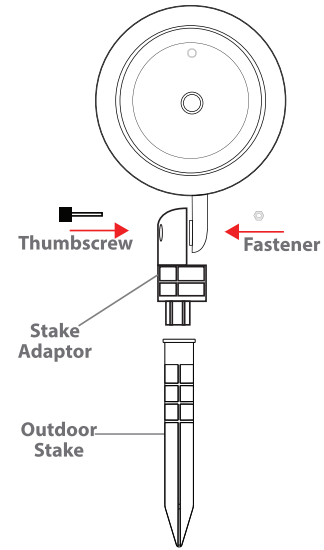

**Plug into an available wall outlet**

**NOTE:** The Laser Light Projector will appear brightest in the dark and may look dimmer if there are competing sources of light.

Only use an extension cord rated for outdoor use (**not included**) with the Laser Light Projector.

**Using the Laser Light Projector**

Press the button on the rear of the light to switch between the different light modes

1. RED+GREEN Light
2. RED+GREEN Light Flash
3. GREEN Light
4. RED Light

**Safety instructions**

**DANGER:**  
**Do not intentionally shine into eyes or face.**

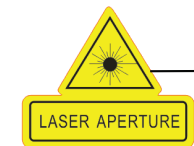
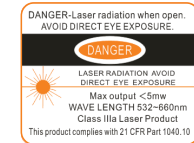

**WARNING:** Lasers should not be projected at or within the flight path of an aircraft within 10 nautical miles from an airport. If your intended surface is within 10 nautical miles of an airport, lower the angle of the Laser Light Projector so that no lasers point into the sky.

**CAUTION:**  
**Do not use the Laser Light Projector in any matter other than that intended by the manufacturer to avoid exposure to hazardous laser radiation.**

Do not attempt to open the Laser Light Projector under any circumstance.

**Legal information**

**READ AND KEEP THESE INSTRUCTIONS.**

Caution: Any changes or modifications not expressly approved could void the user's authority to operate the equipment.

Note: This equipment has been tested and found to comply with the limits for a Class B digital device, pursuant to part 15 of the FCC Rules. These limits are designed to provide reasonable protection against harmful interference in a residential installation. This equipment generates, uses and can radiate radio frequency energy and, if not installed and used in accordance with the instructions, may cause harmful interference to radio communications. However, there is no guarantee that interference will not occur in a particular installation. If this equipment does cause harmful interference to radio or television reception, which can be determined by turning the equipment off and on, the user is encouraged to try to correct the interference by one or more of the following measures:

- Reorient or relocate the receiving antenna.
- Increase the separation between the equipment and receiver.
- Connect the equipment into an outlet on a circuit different from that to which the receiver is connected.
- Consult the dealer or an experienced radio/TV technician for help.

This device complies with Part 15 of the FCC Rules. Operation is subject to the following two conditions: (1) this device may not cause harmful interference, and (2) this device must accept any interference received, including interference that may cause undesired operation.